



LAMPO lighting designers

46042 Castel Goffredo - Mantova - Italy

Via Portogallo, 4

tel +39 0376 770869 fax +39 0376 780947

www.lamposrl.it

e-mail info@lamposrl sales@lamposrl

tech@lamposrl exp@lamposrl

ENGLISH

Discharge centrepiece



DOMINGO 575W

USER'S MANUAL

This manual must be considered an integral part of the projector.

BEFORE CONNECTING AND USING THE PROJECTOR, IT IS IMPORTANT TO READ CAREFULLY ALL THE INSTRUCTIONS IN THIS MANUAL.

QUALIFIED PERSONNEL ONLY, IN COMPLIANCE WITH ALL THE SECURITY LAWS, CAN DO THE INSTALLATION, THE MAINTENANCE AND THE UTILISATION OF THIS PROJECTOR.

BEFORE CONNECTING THE PROJECTOR, MAKE SURE THAT THE FREQUENCY AND THE VOLTAGE VALUES ARE SUITABLE AS SPECIFIED ON THE PROJECTOR.

FOR ANY DOUBT, CONTACT YOUR SUPPLIER OR SEND AN E-MAIL TO:

tech@lamposrl.it

IP20 SOLID: Objects exceeding 12mm diameter
WATER: Non protected

 1.5 m | Minimum distance from lighted objects (meters)

ta °C Rated maximum ambient temperature (35°C indoor with ventilation)

 Connection must be made to a power supply system fitted with efficient earthing (EN60598-1 – Class I fixture)

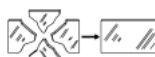
 Replace any cracked protective shield, dichroic filter or lens

 Ignitor circuit lamp have very high voltage
9KV

Index

Dimensions and weight	page 2
Admissible environmental conditions	page 2
Storage	page 2
Power supply	page 2
DMX512 specifications	page 3
DMX signal cable	page 3
Set-up procedures	page 5
DMX strating address	page 5
How to set the options	page 6
Meaning of the options	page 6
Lamp replacement	page 6

Dimensions & weight

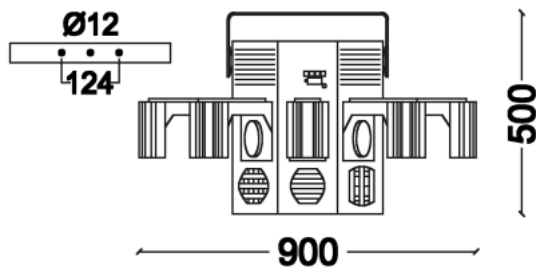

Weight: 38 Kg

Admissible environmental conditions

The projector was engineered and produced to function in indoor areas with an air temperature ranging between 0° and 35°C and with a humidity level between 30 and 90%.

When choosing the installation, please make sure that the device is not exposed to extreme heat or in small area.

Storage

The projector, in its original packing, must be kept in covered, dry areas with a temperature between -10°C and +50°C.

Power supply

The projector can be feed with voltage between 210Vac and 240Vac (on the projector body is specified if 50 or 60 Hz). Over-voltage caned damage the electronic parts of the projector or reduce the lamp life. It is advised to check the electric system before installation.

Use the cable provided inside the junction box. The power line must be protected by a differential MGT breaker, while metal parts, that might be electrically charged through the projector must be grounded. Make sure the projector does not pull the cable in all different working positions, and that sources of heat are not placed in the vicinity.

Connect the fixture to the mains with the enclosed power cord and plug. (Fan and electronic board on the projector) (Power supply on the external ballast). See the table for the colours of the connection-cable.

PIN	SYMBOL	EC	US	UK
phase	L	brown	yellow/c	red
neutral	N	blue	silver	black
earth		yellow/green	green	green

When in doubt, consult a qualified electrician.

Be careful with your operations. With a high voltage you can suffer a dangerous electric shock when touching the wires! Inside the projector, the ignitor circuit have very high voltage, over 5Kv.

The User must ensure that the power supply is provided with a highly sensitive differential circuit breaker 30m/A to protect the projector from indirect contacts, and that the grounding system PE is working properly.

Don't power the projector with a dimmer circuit

DMX512 specifications

The projector reads 5 consecutive DMX channels starting from the set address.

Channel	Function
1	Tilt couple 1/5
2	Tilt couple 2/6
3	Tilt couple 3/7
4	Tilt couple 4/8
5	Colour level

Tilt channels

The Tilt movement of the 4 couples of mirrors is controlled referring to the received values on the DMX channels (1-2-3-4).

Colour selection

The DMX 5 channel selects the colour requested.

Function	Dmx Values	Notes
Colour 3	224..255	
Colour 2	192..223	
Colour 2	160..191	
Colour 2	128..159	
Colour 2	96..127	
Colour 2	64..95	
Colour 2	32..63	
Colour 1	0..31	

DMX signal cable

Use only shielded and twisted cables with EIA485 (RS485) standards. The cable must be low capacity and an impedance between 82 and 120 ohm.

It is preferable not to use audio cables.

We advise you to read the example of the following tables as a reference to use to correct cables.

Cables with 1 pair of wires

Type	Cod.	AWG	Impedance (ohm)
BELDEN	1162A	20	100
BELDEN	8227	20	100
BELDEN	89207	20	100
ALPHA	9109	20	100
ALPHA	9817	20	100
ALPHA	9818	20	100

Cables with 2 pairs of wires

Type	Cod.	AWG	Impedance (ohm)
BELDEN	8102	24	100
BELDEN	8162	24	100
BELDEN	89696	22	100
PROPLEX	PC224P	22	110
PROPLEX	PC224T	22	110

The wire size we recommended is 26 AWG or higher. It is preferable:

- not to insert over 32 projectors each DMX chain
- not to use more than 150m of signal cable (with low quality cable)
- not to use more than 300m of signal cable (with good quality cable)

Standard DMX controllers have only one signal out-put. If more than 32 projectors are used it is necessary to have a signal SPLITTER, that will duplicate the signal in 2 or more lines.

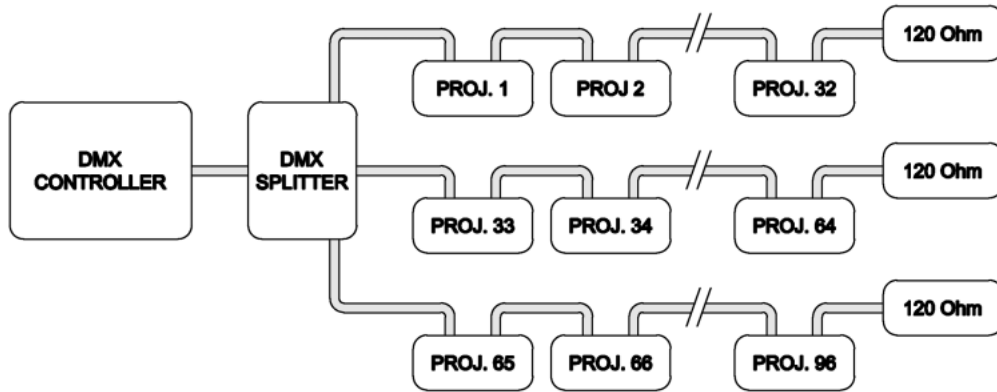

If the signal cable is very long, it is necessary to install a signal AMPLIFIER on the DMX line (at least every 300m of good quality cable), so that it will repeat the signal to the following projectors.

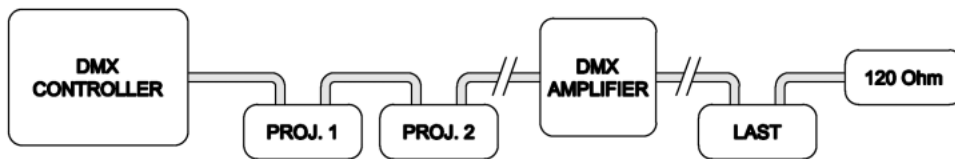

On the last projector of the signal chain it is necessary to insert a resistor (from 82 to 120 ohm) between positive and negative terminal (+ and -).

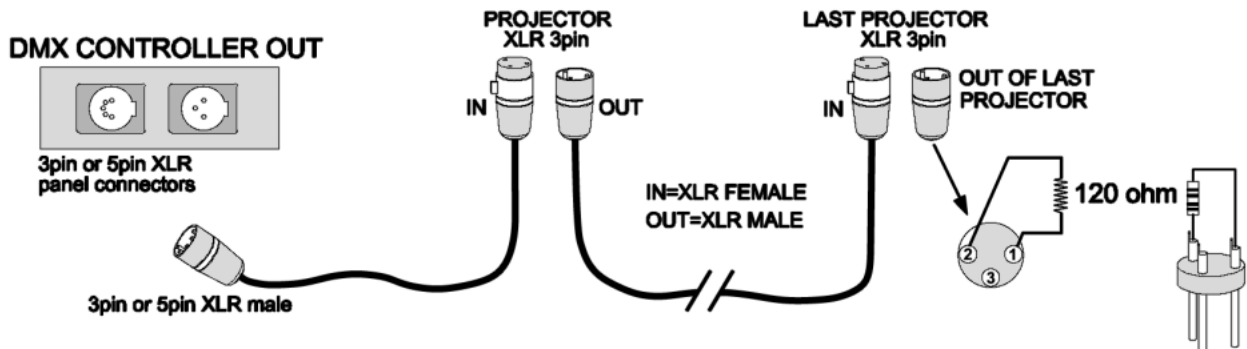

Use MALE XLR 3 or 5 pin connector to connect the projectors to the DMX controller.

Use MALE / FEMALE 3 pin connectors to connect the projector to projector.

Solder on PIN 1 of the XLR connector the shield of the signal cable, on PIN 2 solder the negative (example: black wire of cable) and on PIN 3 solder the positive (example: red or white wire of the cable).

The sequences and the colours has to be the same on each projector, do not change the sequences

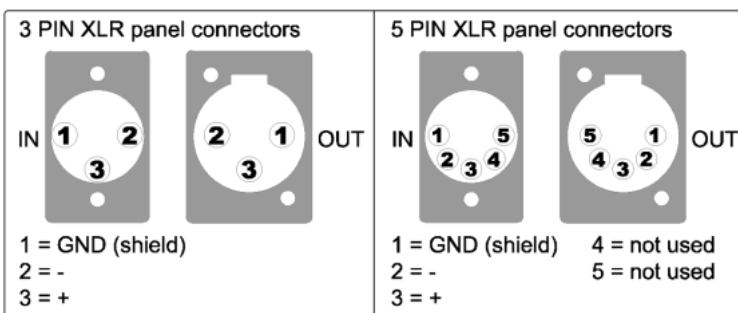

Set-up procedure

The projector needs to receive a group of 5 consecutive DMX channels. The starting DMX address and the options are set with the four buttons above the display. Once set, address and options are recorded in an E²PROM memory. Every time the projector is switched on (or after any changes of the program), it will re-set itself depending on the values of the parameters read from the memory.

In this section is shown how to do the operations of the DMX address and On/Off option configurations.

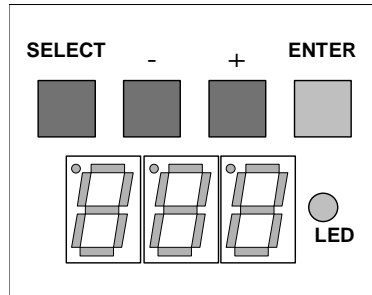

The four buttons have the following functions:

The "**SELECT**" button allows the operator to change the display modalities, indicated from the double coloured LED status that is located next to the buttons; if you do not press buttons, the unit automatically restores the standard functioning mode after a while.

Actions on the SELECT button	Display modalities	LED status and colour
No action (normal status)	Visualisation of the DMX address or automatic/musical mode (Aon	if GREEN Reception of DMX OK if FLASHING GREEN: Absence of DMX signal if RED Automatic/musical mode (Aon)
Pressing once the button	Modifies DMX address	FLASHING RED
Pressing twice the button	Modifies first option (Aon/of)	FLASHING RED
Pressing three times the button	Modifies second option (2on/of)	FLASHING RED
Pressure after last option	Back to the visualisation of the address	GREEN (ON or FLASHING) or RED if (Aon)

The **MINUS** button is to **reduce** the visualised number on the display, or to **disable** the selected option. In the case of numeric settings, if the button is kept pressed, the address is continuously reduced.

The **PLUS** button is to **increase** the visualised number on the display, or to **enable** the selected options. In the case of numeric settings, if the button is kept pressed, the address is continuously increased.

The **ENTER** button is to **confirm** the modified setting. After pressing this button, the display flashes briefly and the actual value is recorded.

N.B.: If the **ENTER** button is not pressed, all the selected modifications are cancelled.

DMX starting address

- 1) Be sure that the display is on the normal status, which is with green LED (on or flashing) or red (on). If it is not activated the automatic mode, the visualised number shows the actual DMX address.
- 2) Press once the **SELECT** button. The LED is flashing red.
- 3) To modify the address value use the PLUS and MINUS buttons.
- 4) Press the **ENTER** button to confirm the settings. You have the visual confirmation of the recording when the display is flashing quickly.
- 5) Press more times the **SELECT** button to go back to the normal status.

How to set the options

- 1) Be sure that the display is on normal status, that is the LED is green (on or flashing) or red (on). If the automatic mode is not active, the visualised number indicates the DMX address actually in use.
- 2) Press once the **SELECT** button. The LED is flashing red.
- 3) Press the **SELECT** button once more. The display shows the status of the first option (Aon/of).
- 4) If this is not the desired option, press the **SELECT** button until the required option is found.
- 5) To modify the option's status use the **PLUS** or **MINUS** button, that select the status (disable/enable).
- 6) Press the **ENTER** button to confirm and record the setting. All the display will flash quickly to indicate the recording has been done.

Meaning of the Options

Display	Option's name	Description
Aon/of	<u>Automatic/Musical Mode</u>	Enables/disables the inside program in automatic musical mode
2on/of	<u>Double Movement</u>	Enables/disables the double movement at every musical inputs

Lamp Replacement

- 1) Disconnect the projector from the main power supply
- 2) Unscrew the screws of the lamp cover (bottom of projector)
- 3) Remove the lamp, taking care to wear proper protective gloves
- 4) Insert a new lamp
- 5) Close the lamp cover and tight the screws

Use HM/MSI 575 discharge lamp, socket SFc10

DISCHARGE LAMPS CONTAIN SUBSTANCES THAT CAN POLLUTE THE AMBIENCE. DISPOSE OF USING THE APPROPRIATE REFUGES (TOXIC).

The improper use of this projector, cancel the guarantee and our responsibility. All the information have been written and driven with extreme care; however, we do not engage us any responsibility for contingent errors or omissions. We reserve the right to modify and/ or improve our product as we retain necessary, without subsequent warning or notice. It is forbidden any complete or partial reproduction of this handbook, if not expressly authorized.