

**For more information:**

Philips Lighting B.V.  
UV Health and Wellness  
Zwaanhoefstraat 2  
4702 LC Roosendaal  
The Netherlands  
Tel: + 31 165 577906  
Email: [uvpurification@philips.com](mailto:uvpurification@philips.com)  
Web: [www.philips.com/uvpurification](http://www.philips.com/uvpurification)



# Ultraviolet purification application information

Perfection preserved by the purest of light



©2006 Koninklijke Philips Electronics N.V.  
All rights reserved.

Data subject to change  
3222 635 61801  
11/06

**Distributor:**

  
**Techni-Lux**  
[www.techni-lux.com](http://www.techni-lux.com)

Phone: 407-857-8770  
Fax: 407-857-8771  
Email: [sales@techni-lux.com](mailto:sales@techni-lux.com)

**PHILIPS**

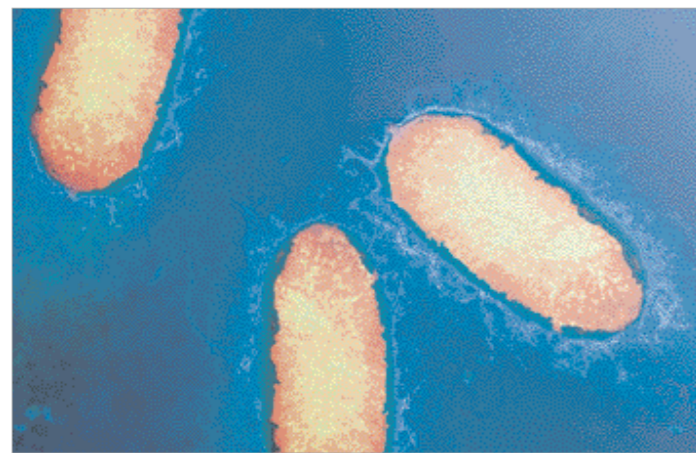
# Contents

<b>Preface</b>		4
1. Micro-organisms	<b>General</b>	5
	1.1 Bacteria and bacterial spores	5
	1.1.1 Bacteria	5
	1.1.2 Bacterial spores	5
	1.2 Moulds and yeasts	5
	1.2.1 Moulds	6
	1.2.2 Yeasts	6
	1.3 Viruses	6
2. Ultraviolet light	<b>General</b>	8
	2.1 Generation and characteristics of short-wave UV light	9
	2.2 Germicidal action	10
3. Purification by means of ultraviolet lamps	<b>General</b>	13
	3.1 Air purification	13
	3.1.1 Ceiling-mounted Philips TUV lamps	14
	3.1.2 Philips TUV lamps for upper-air irradiation using upward facing reflectors	14
	3.1.3 Philips TUV lamps for irradiation using downward facing reflectors	15
	3.1.4 Philips TUV lamps in air ducts	15
	3.1.5 Philips TUV lamps in stand alone units	16
	3.2 Surface purification	17
	3.3 Liquid purification	17
4. Applications	<b>General</b>	20
	4.1 Water purification	20
	4.1.1 Municipal waste water	21
	4.1.2 Municipal drinking water	21
	4.1.3 Residential drinking water	22
	4.1.4 Water coolers, dispensers	22
	4.1.5 Semiconductors process water	22
	4.1.6 Spas and swimming pools	23
	4.1.7 Cooling towers	23
	4.1.8 Miscellaneous	23
	4.2 Air purification	24
	4.3 Cooling coils	25
	4.4 Philips germicidal lamps and their application	25
5. Lamp data	<b>General</b>	27
	5.1 UV irradiance values	27
	5.2 Influence of temperature	28
	5.3 Lamp life	28
6. References		29

# Preface

Pollution of the macro and micro environment has caused concerns for decades and in recent times the macro consequences have been subjected to agreed international protocols, aimed at reducing pollution. Additionally, national and international laws now exist to limit the existence of micro-organisms, particularly those which affect human, animal and bird health in the environment and the food chain. A consequence of this concern has been that pollution reduction is now an industry, covering areas such as changing technologies to reduce primary and consequential pollution and chemical, biological and physical cleaning. Included in these techniques is purification using ultraviolet (UV) C light (UVC), which has the benefit of being both efficient and arguably the most energy effective technology.

UVC purification has a long and honourable history in cleaning room air. However, growth in other applications such as high-tech volume liquid treatment and domestic ponds has expanded, whilst surface treatment of food has been used to extend shelf life in supermarkets, resulting in less waste food and lower stockholdings.



Whilst UVC can be used as the exclusive solution in some applications, it is often used in tandem with other techniques. It follows that a single technology solution

approach is unlikely to be ideal. It also follows that since UVC is so simple and energy effective, it is perhaps wise to consider this option first.

Philips Lighting has been closely associated with progress in this field by developing, manufacturing and marketing lamps generating UVC and continues to research new lamp configurations. This brochure is the fourth survey of information to be aimed at production and technical staff in organisations where micro-organisms present problems.

Micro-organisms such as bacteria, moulds, yeast's and protozoa can be destroyed or removed by physical, biological and chemical methods. UVC works using a photolytic effect whereby the radiation destroys or inactivates the micro-organism so that it can no longer multiply.

For DNA it does this by causing adjacent thymine bases to form a chemical bond thus creating a dimer and if sufficient of these are created, DNA cannot replicate. Some micro-organisms can repair themselves by absorbing UVA. In other cases UVC (and indeed UVA or UVB) can cause bond splitting in a molecule resulting in the creation of free radicals, which are often highly labile and which can react together to produce an inert end product. For purifying these effects are produced by wavelengths below 320 nm, with the optimum effect occurring at around 260 nm. The phenomenon whereby micro-organisms can be disfigured or destroyed is independent of host state (fluid or solid). Indeed with pH or temperature, the important feature of the action is that radiation can reach the organism; this means that a bacterium shadowed by another or by a particle will escape attack. Unlike other techniques, UVC photolysis rarely produces potentially dangerous by-products.

# I. Micro-organisms

## General

Micro-organisms are primitive forms of life. Their small dimensions not only constituted the original reason for classifying them separately from animals and plants but are also relevant to their morphology, the activity and flexibility of their metabolism and their ecological distribution. They include protozoa, bacteria and moulds.

Cellular death in the case of micro-organisms refers to the loss of the ability to grow and to multiply, or in practical terms, to the loss of the ability to cell divide.

Sterilisation means that all micro-organisms are killed. Pasteurisation or the use of preservatives lead to reduction of the total amount of micro-organisms. Purification can be achieved through moist heat, dry heat, filtration, chemical agents and ultraviolet (UV) radiation.

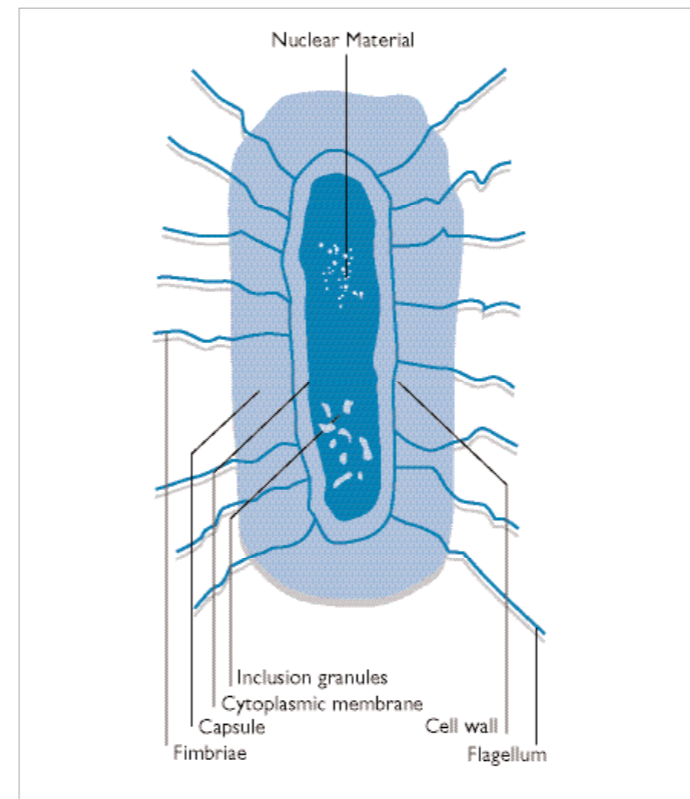


Figure 1. The main components of a typical bacterial cell.

## I.1 Bacteria and bacterial spores

### I.1.1 Bacteria

Bacteria is the name given to a large group of organisms, which can be both uni and multicellular; they have a simple nuclear mass, and multiply rapidly by simple fission. The structure of typical bacterial cell is shown in figure 1 and examples of their shapes are given in figure 2.

Bacteria occur in air, water, soil, rotting organic material, animals and plants. Saprophytic forms (those living on decaying organic matter) are more numerous than parasitic forms; the latter include both animal and plant pathogens. A few species of bacteria are autotrophic, i.e. able to build up food materials from simple substances.



Figure 2. Some examples of bacteria varieties.

### I.1.2 Bacterial spores

Bacterial spores are resistant to extreme conditions, such as high temperatures and dryness; for instance some bacterial spores, can stand a temperature of 120°C without losing their capability for germination. Viable spores of bacillus subtilis have been found in earth that has been dry for hundreds of years, thus demonstrating their ability to survive under extremely unfavourable conditions.

## I.2 Moulds and yeasts

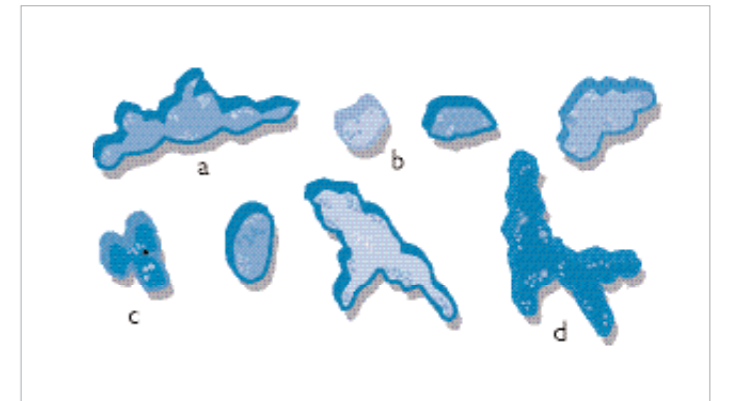
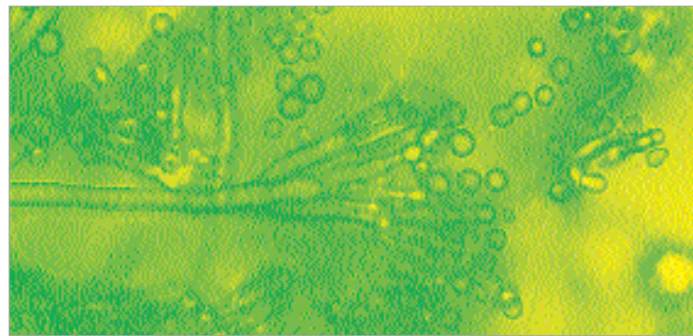


Figure 3. Brewer's yeast (*Saccharomyces cerevisiae*) in various stages of development: a. Various forms b. Yeast cell with spores c. Yeast spores d. Yeast spores after germination.

### 1.2.1 Moulds

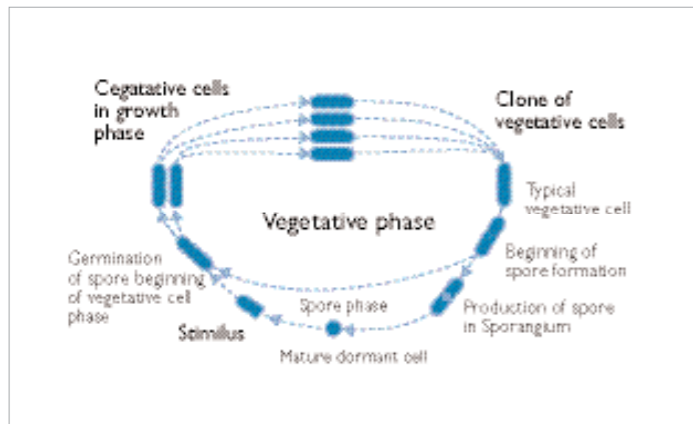
The variety of moulds is immense and they are found everywhere. Many are saprophytic, causing food spoilage resulting in enormous damage; some are pathogenic (parasitic).



**Figure 4.** Mould culture, as seen through the microscope, showing the fungus mycelium with spores forming as beads at the extremities. These spores detach as the result of the formation of further spores pushing from behind. In the photograph many spores have already become detached and begun to move away freely.

Amongst the diseases caused by moulds, the most frequent are fungal infections of the skin and diseases of the mucous membranes.

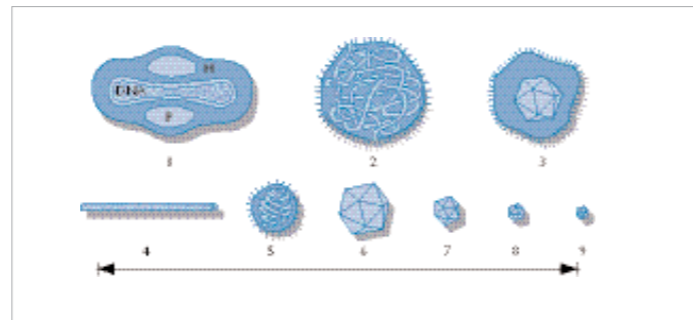
Certain kinds of mould form antibiotic substances; these have given rise to the highly important antibiotics industry. Penicillin and streptomycin are early examples. A mould (see figures 4 and 5) consists of a mycelium and special structures, (sporangia and conidiophores, for example), which result in the formation of spores. In a favourable environment, a mould spore germinates and a mesh of fine filaments (hyphae) is formed. The filaments together form the mycelium, which takes up food and water from the surface on which the spore has germinated. Spores, and the manner, in which they are formed, play a considerable part in the classification of moulds.



**Figure 5.** 'Life cycle' of spore formers.

### 1.2.2 Yeasts

Yeasts are unicellular moulds. They differ from the other moulds in the way that they propagate. Yeasts (figure 3) multiply by means of budding or sprouting. A selection of yeasts are used in various industries, the most important of these being those where fermentation produces wine, beer, vinegar and bread. The action of fermentation is the enzymatic transformation of the particular organic substrate, for instance the alcoholic fermentation of carbohydrates. Some yeasts are pathogenic.



**Figure 6.** Relative shapes and sizes of some types of viruses.

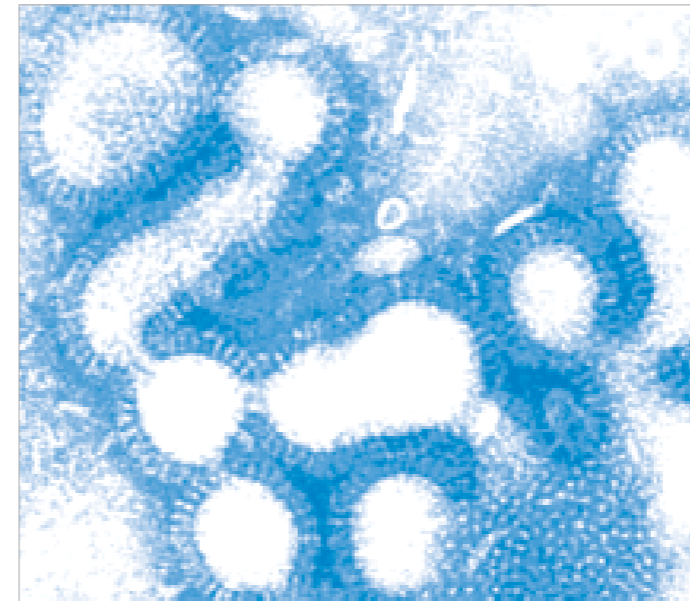
- |                             |                            |
|-----------------------------|----------------------------|
| 1. Smallpox virus           | 4. Tobacco mosaic virus    |
| Abbreviations:              | 5. Influenza virus         |
| DNA = virus DNA             | 6. Insect polyhedral virus |
| P = elliptical protein body | 7. Adeno virus             |
| H = enveloping layers       | 8. Polyoma virus           |
| 2. Mumps virus              | 9. Poliomyelitis virus     |
| 3. Herpes virus             |                            |

### 1.3 Viruses

Viruses are a group of biological structures with extremely small dimensions (figure 8) which are obligatory parasitic. Viruses are so small that bacterial filters do not retain them, neither do they precipitate in normal centrifuges. They can be observed by using an electron microscope (figure 7). Viruses are unable to grow and multiply by division, they can only grow in living cells, so by their multiplication they kill the host cell.

The same process can take place in adjacent cells and eventually whole cellular complexes can be destroyed. Tissue damage is a way of recognising the presence of a virus.

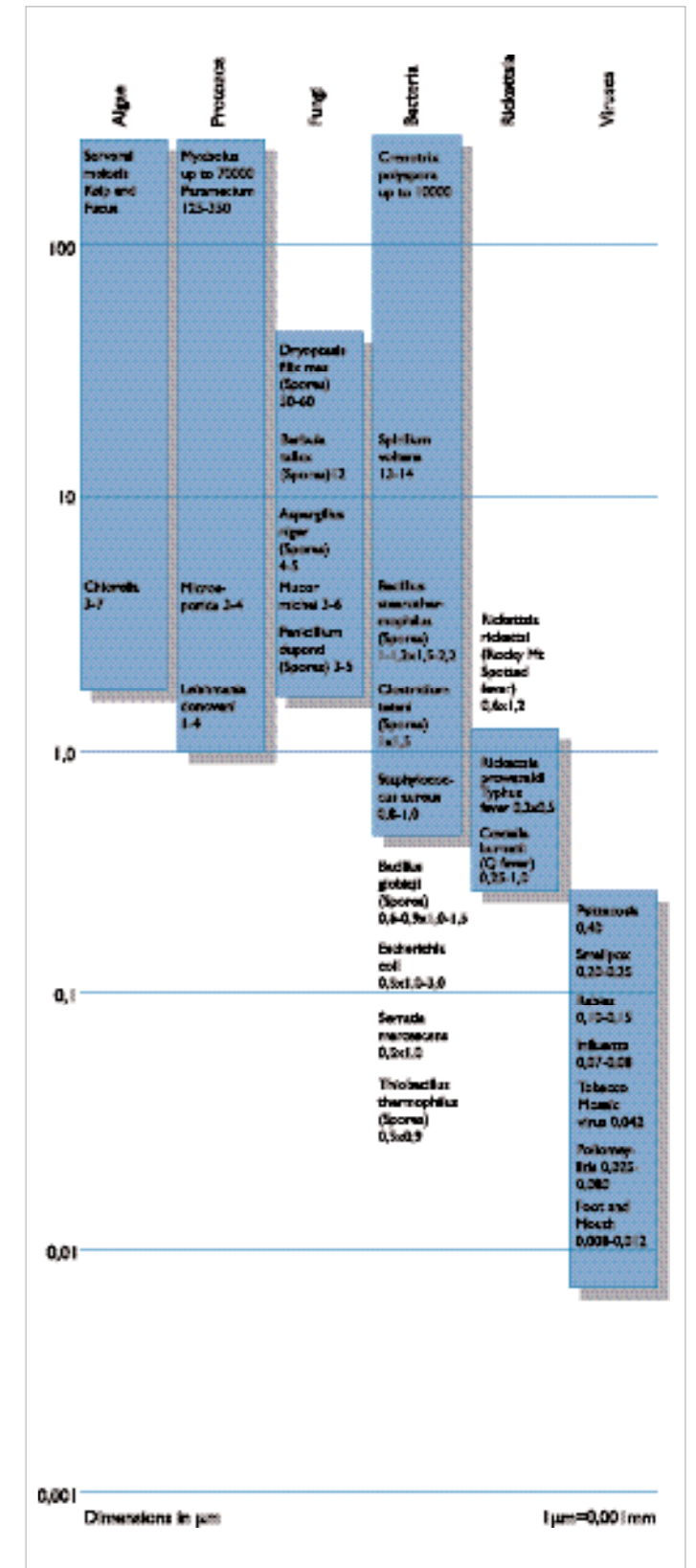
Viruses have been identified as the causative agent of disease in humans, animals, plants and bacteria themselves (bacteriophage). In human beings they are the cause of diseases such as chickenpox, mumps, measles, warts, poliomyelitis, the common cold and influenza (figure 6).



**Figure 7.** One of the types of influenza virus as seen enlarged 3600 times by means of an electron microscope. This virus occurs in the form of filaments and globules having a diameter of approximately 0.1mm.

In animals; foot-and-mouth disease, Newcastle disease and bird flu are amongst the diseases caused by viruses.

Plants are also subject to many mosaic diseases caused by viruses. An interesting case is that of 'parrot' tulips. Formerly these were regarded as a separate variety, because of their feathery looking petals and their combinations and patterns of color. It has now been shown that the color pattern and shape of the petals results from a virus, which has no destructive effect on the tulip itself, or its reproductive powers. The attractive colors and patterns of the petals are the symptoms of the 'disease'.



**Figure 8.** Relative sizes of different types of micro-organisms.

## 2. Ultraviolet light

### General

Ultraviolet (UV) is that part of electromagnetic light bounded by the lower wavelength extreme of the visible spectrum and the X-ray radiation band. The spectral range of UV light is, by definition between 100 and 400 nm (1 nm=10<sup>-9</sup>m) and is invisible to human eyes. Using the CIE classification the UV spectrum is subdivided into three bands:

- UVA (long-wave) from 315 to 400 nm
- UVB (medium-wave) from 280 to 315 nm
- UVC (short-wave) from 100 to 280 nm

In reality many photobiologists often speak of skin effects from the weighted effect of wavelength above and below 320 nm, hence offering an alternative definition.

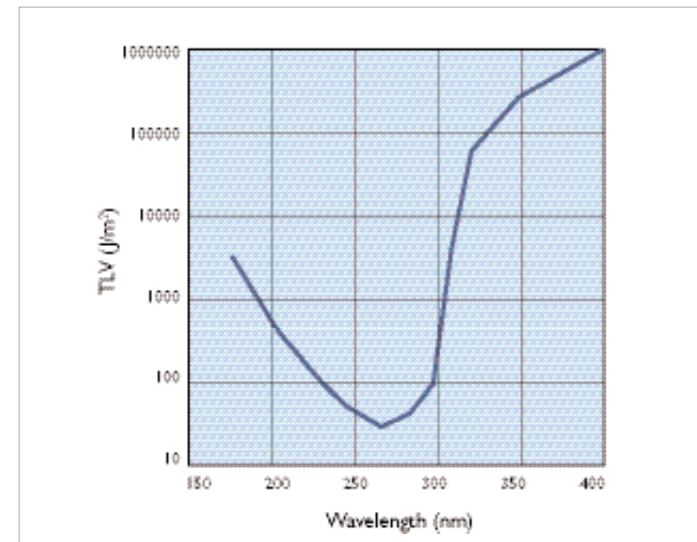


Figure 9. UV Light Threshold Limited Values (TLV) according to ACGIH 1999-2000 (Ref 1).

A strong germicidal effect is provided by the Light in the short-wave UVC band. In addition erythema (reddening of the skin) and conjunctivitis (inflammation of the mucous membranes of the eye) can, also be caused by this form of Light. Because of this, when germicidal UV-Light lamps are used, it is important to design systems to exclude UVC leakage and so avoid these effects.

Self evidently people should avoid exposure to UVC. Fortunately this is relatively simple, because it is absorbed by most products, and even standard flat glass absorbs all UVC. Exceptions are quartz and PTFE. Again fortuitously, UVC is mostly absorbed by dead skin, so erythema

can be limited. In addition UVC does not penetrate to the eye's lens; nevertheless, conjunctivitis can occur and though temporary, it is extremely painful; the same is true of erythema effects.

Permissible UVC Exposures	
Duration of exposure per day	Irradiance ( $\mu\text{W}/\text{cm}^2$ )
8 hours	0.2
4 hours	0.4
2 hours	0.8
1 hour	1.7
30 minutes	3.3
15 minutes	6.6
10 minutes	10
5 minutes	20
1 minute	100

Table 1. Permissible 254 nm UV exposures, according to ACGIH.

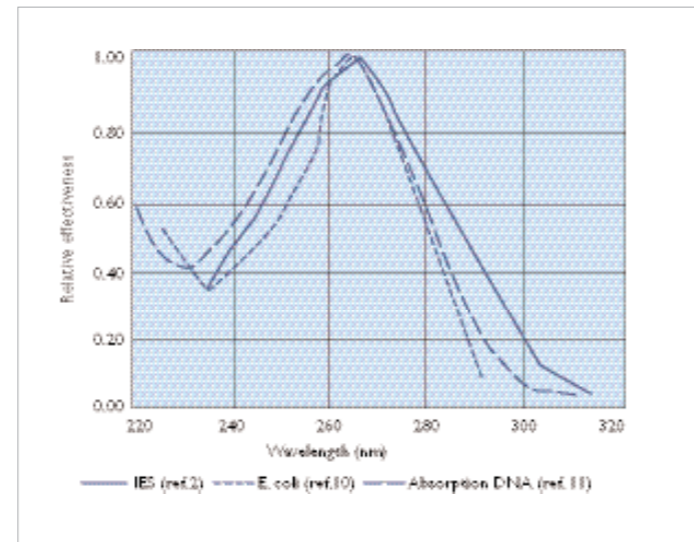


Figure 10. Germicidal action spectrum.

Where exposure to UVC Light occurs, care should be taken not to exceed the threshold level norm. Figure 9 shows these values for most of the CIE UV spectrum. In practical terms, table 1 gives the American Congress of Governmental and Industrial Hygienist's (ACGIH) UV Threshold Limit Effective Irradiance Values for human exposure related to time. At this time it is worth noting that radiation wavelengths below 240 nm forms ozone, O<sub>3</sub> from oxygen in air. Ozone is toxic and highly reactive; hence precautions have to be taken to avoid exposure to humans and certain materials.

### 2.1 Generation and characteristics of short-wave UV light

The most efficient source for generating UVC is the low-pressure mercury discharge lamp, where on average 35% of input watts is converted to UVC watts. The radiation is generated almost exclusively at 254 nm viz. at 85% of the maximum germicidal effect (figure 10). Philips' low pressure tubular fluorescent ultraviolet (TUV) lamps have an envelope of special glass that filters out ozone-forming radiation, in this case the 185 nm mercury line. The spectral transmission of this glass is shown in figure 11 and the spectral power distribution of these TUV lamps is given in figure 12.

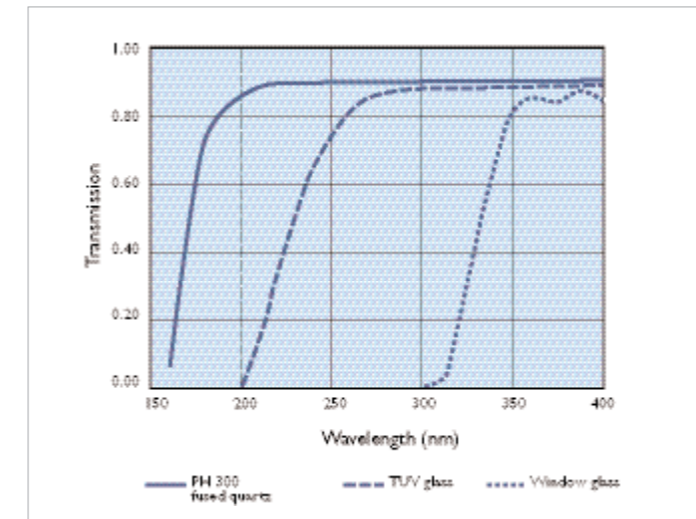


Figure 11. Special transmission of glasses (1mm).

For various Philips germicidal TUV lamps the electrical and mechanical properties are identical to their lighting equivalents.

This allows them to be operated in the same way i.e. using an electronic or magnetic ballast/starter circuit. As with all low pressure lamps, there is a relationship between lamp operating temperature and output. In low pressure lamps the resonance line at 254 nm is strongest at a certain mercury vapour pressure in the discharge tube. This pressure is determined by the operating temperature and optimises at a tube wall temperature of 40°C, corresponding with an ambient temperature of about 25°C. (See page 28, figure 28). It should also be recognised that lamp output is affected by air currents (forced or natural) across the lamp, the so called chill factor. The reader should note that, for some lamps, increasing the air flow and/or decreasing the temperature can increase the germicidal output. This is met in high output (HO) lamps viz. lamps with higher wattage than normal for their linear dimension. (See page 28, figure 29).

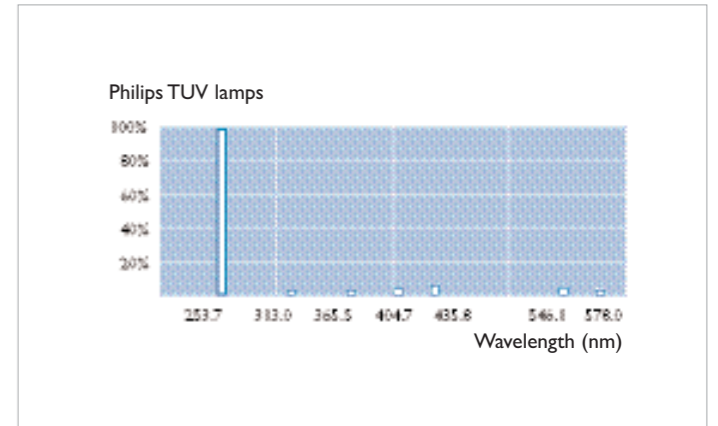


Figure 12. Relative spectral power distribution of Philips TUV lamps.

A second type of UV source is the medium pressure mercury lamp, here the higher pressure excites more energy levels producing more spectral lines and a continuum (recombined radiation) (figure 13). It should be noted that the quartz envelope transmits below 240 nm so ozone can be formed from air.

The advantages of medium pressure sources are:

- High power density
- High power, resulting in fewer lamps than low pressure types being used in the same application
- Less sensitivity to environment temperature. The lamps should be operated so that the wall temperature lies between 600 and 900°C and the pinch does not exceed 350°C. These lamps can be dimmed, as can low pressure lamps

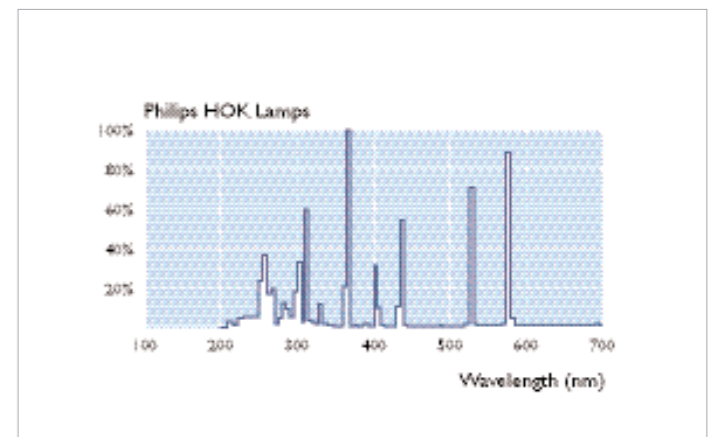


Figure 13. Relative spectral power distribution of Philips HOK and HTK lamps.

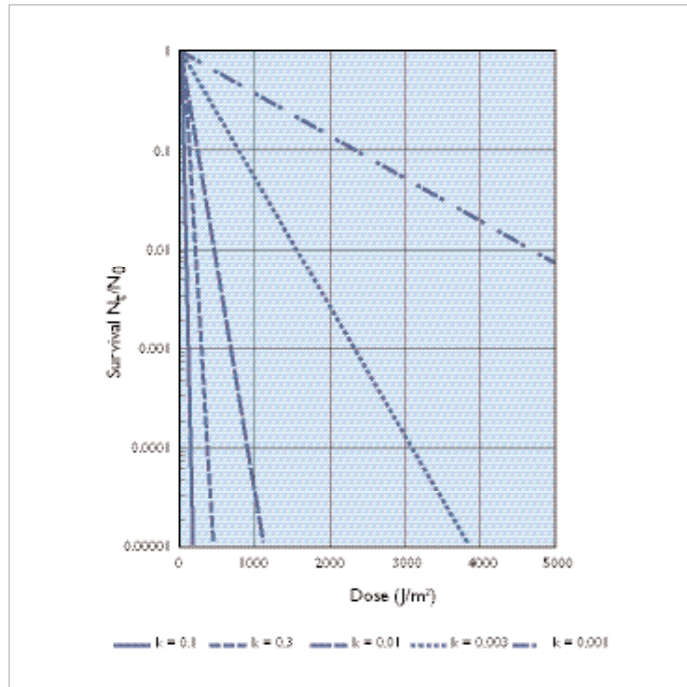


Figure 14. Survival of micro-organisms depending on dose and rate constant k.

## 2.2 Germicidal action

The UV light emitted by a source is expressed in watts (W) and the irradiation density is expressed in watts per square meter (W/m²). For germicidal action dose is important. The dose is the irradiation density multiplied by the time (t) in seconds and expressed in joules per square meter (J/m²). (1 joule is 1W.second).

From figure 10 it can be seen that germicidal action is maximised at 265 nm with reductions on either side. Low pressure lamps have their main emission at 254 nm where the action on DNA is 85% of the peak value and 80% on the IES curve. For wavelengths below 235 nm the germicidal action is not specified, but it is reasonable to assume that it follows the DNA absorption curve.

Micro-organisms effective resistance to UV light varies considerably. Moreover, the environment of the particular micro-organism greatly influences the radiation dose needed for its destruction. Water, for instance, may absorb a part of the effective radiation depending on the concentration of contaminants in it. Iron salts in solution are well known inhibitors. Iron ions absorb the UV light. The survival of micro-organisms when exposed to UV light is given by the approximation:

$$N_t/N_0 = \exp. (-kE_{\text{eff}}t) \dots\dots\dots 1$$

$$\text{Hence } \ln N_t/N_0 = -kE_{\text{eff}}t \dots\dots\dots 2$$

- $N_t$  is the number of germs at time t
  - $N_0$  is the number of germs before exposure
  - k is a rate constant depending on the species
  - $E_{\text{eff}}$  is the effective irradiance in W/m²
- The product  $E_{\text{eff}}t$  is called the effective dose  $H_{\text{eff}}$  and is expressed in W.s/m² or J/m²

It follows that for 90% kill equation 2 becomes

$$2.303 = kH_{\text{eff}}$$

Some k value indications are given in table 2, where they can be seen to vary from 0.2 m²/J viruses and bacteria, to  $2.10^{-3}$  for mould spores and  $8.10^{-4}$  for algae. Using the equations above, figure 14 showing survivals or kill % versus dose, can be generated.

UV dose to obtain 90% killing rate		
Bacteria	Dose	k
Bacillus anthracis	45.2	0.051
B. megatherium sp. (spores)	27.3	0.084
B. megatherium sp. (veg.)	13.0	0.178
B. paratyphosus	32.0	0.072
B. subtilis	71.0	0.032
B. subtilis spores	120.0	0.019
Campylobacter jejuni	11.0	0.209
Clostridium tetani	120.0	0.019
Corynebacterium diptheriae	33.7	0.069
Dysentery bacilli	22.0	0.105
Eberthella typhosa	21.4	0.108
Escherichia coli	30.0	0.077
Klebsiella terrifani	26.0	0.089
Legionella pneumophila	9.0	0.256
Micrococcus candidus	60.5	0.038
Micrococcus sphaeroides	100.0	0.023
Mycobacterium tuberculosis	60.0	0.038
Neisseria catarrhalis	44.0	0.053
Phytomonas tumefaciens	44.0	0.053
Pseudomonas aeruginosa	55.0	0.042
Pseudomonas fluorescens	35.0	0.065
Proteus vulgaris	26.4	0.086
Salmonella enteritidis	40.0	0.058
Salmonella paratyphi	32.0	0.072
Salmonella typhimurium	80.0	0.029
Sarcina lutea	197.0	0.012
Serratia marcescens	24.2	0.095
Shigella paradysenteriae	16.3	0.141
Shigella sonnei	30.0	0.077
Spirillum rubrum	44.0	0.053
Staphylococcus albus	18.4	0.126
Staphylococcus aureus	26.0	0.086
Streptococcus faecalis	44.0	0.052
Streptococcus hemoliticus	21.6	0.106
Streptococcus lactus	61.5	0.037
Streptococcus viridans	20.0	0.115
Sentertidis	40.0	0.057
Vibrio cholerae (V.comma)	35.0	0.066
Yersinia enterocolitica	11.0	0.209

Table 2. Doses for 10% survival under 254 nm radiation (J/m²) and rate constant k (m²/J), Ref 2, 3, 4, 5, 6 and 7

UV dose to obtain 90% killing rate		
Yeasts	Dose	k
Bakers' yeast	39	0.060
Brewers' yeast	33	0.070
Common yeast cake	60	0.038
Saccharomyces cerevisiae	60	0.038
Saccharomyces ellipsoideus	60	0.038
Saccharomyces sp.	80	0.029

Mould spores		
	Dose	k
Aspergillus flavus	600	0.003
Aspergillus glaucus	440	0.004
Aspergillus niger	1320	0.0014
Mucor racemosus A	170	0.013
Mucor racemosus B	170	0.013
Oospora lactis	50	0.046
Penicillium digitatum	440	0.004
Penicillium expansum	130	0.018
Penicillium roqueforti	130	0.018
Rhizopus nigricans	1110	0.002

Virus		
	Dose	k
Hepatitis A	73	0.032
Influenza virus	36	0.064
MS-2 Coliphase	186	0.012
Polio virus	58	0.040
Rotavirus	81	0.028

Protozoa		
	Dose	k
Cryptosporidium parvum	25	0.092
Giardia lamblia	11	0.209

Algae		
	Dose	k
Blue Green	3000	0.0008
Chlorella vulgaris	120	0.019



## 3. Purification by means of ultraviolet lamps

### General

In practice, germicidal applications and design factors are governed by three main factors:

#### A. The effective dose (Heff)

Effective dose is the product of time and effective irradiance (the irradiance that makes a germicidal contribution). However, dose is severely limited by its ability to penetrate a medium. Penetration is controlled by the absorption co-efficient; for solids total absorption takes place in the surface; for water, depending on the purity, several 10s of cm or as little as a few microns can be penetrated before 90% absorption takes place.

#### B. The possible hazardous effects of such radiation

Germicidal radiation can produce conjunctivitis and erythema, therefore people should not be exposed to it at levels more than the maximum exposure given in figure 9. It follows that this needs to be taken into consideration when designing purification equipments. Germicidal applications can be and are used for all three states of matter, viz. gases (air), liquids (mainly water) and solids (surfaces) with greatest technical success in those applications where the absorption coefficient is smallest.

However, some notable success has been achieved in applications where, despite a disadvantageous absorption, "thin film" or closed circuit (recycling the product) design techniques have provided effective solutions.

#### C. Lamps

Five Philips ranges of lamps are available for purification purposes:

- Classic Philips T5 and T8 TUV lamps
- High output Philips TUV lamps
- Philips PL-S and PL-L twin-tube compact TUV lamps
- And the newest addition: Philips extreme power technology (XPT) amalgam germicidal lamps in various diameters

All of these are based on low pressure mercury technology. Increasing the lamp current of low pressure lamps produces higher outputs for lamps of the same length; but at the cost of UV efficiency (UV watts/input watts); this is due to higher self-absorption levels, and temperature influences. The application of mercury amalgams, rather than pure mercury, in the lamps corrects for the latter.

- Philips HOK lamps, which are of the medium pressure mercury type, mainly characterized by a much higher UVC output than low pressure options, but at much lower efficacies

The choice of the lamp type depends on the specific application. (See chapter 4.4). In most cases the low pressure types are the most attractive. This is because germicidal lamps are highly efficient in destroying micro-organisms, hence there is limited need for high wattage lamps. For water purification, low and medium pressure are both used, although the choice is not necessarily based on UVC efficacy. Initial total systems costs, including metalwork and space limitations, can be the driving factor rather than efficacy.

#### D. Systems

Near lamps Philips provides also inhouse manufactured ballasts and sleeves to offer a complete system solution for ultimate performance.

### 3.1 Air purification (Ref. 12,13)

Good results are obtained with this form of purification because air has a low absorption coefficient and hence allows UVC to attack micro-organisms present. In addition, two other beneficial conditions are generally present, viz. random movements allowing bacteria etc. to provide favorable molecular orientations for attack and high chances of "closed circuit" conditions, that is second, third and more recycle opportunities. From this, it is evident that air purification is an important application for UV light.

Even in the simplest system (natural circulation) there is an appreciable reduction in the number of airborne organisms in a room. Thus the danger of airborne infection, a factor in many illnesses, is considerably reduced.

However, it should be remembered that purified air is not, in itself, a purifying agent.

Presently, there are five basic methods of air purification using UV lamps viz:

- a. Ceiling or wall mounted Philips TUV lamps
- b. Philips TUV lamps (in upwards-facing reflectors) for upper-air irradiation.
- c. Philips TUV lamps (in downwards-facing reflectors) for irradiation of the floor zone (often in combination with b.).
- d. Philips TUV lamps in air ducts sometimes in combination with special dust filters.
- e. Philips TUV lamps, incorporated in stand-alone air cleaners with a simple filter.

### 3.1.1 Ceiling-mounted Philips TUV lamps

This method is used in those cases where either the interior is unoccupied or where it is possible for the occupants to take protective measures against light. These protective measures entail covering the:

<b>Face</b>	glass spectacles, closefitting goggles or plastic face visors
<b>Hands</b>	gloves (for long exposure, special plastic is preferable to rubber)
<b>Head and neck</b>	head cover

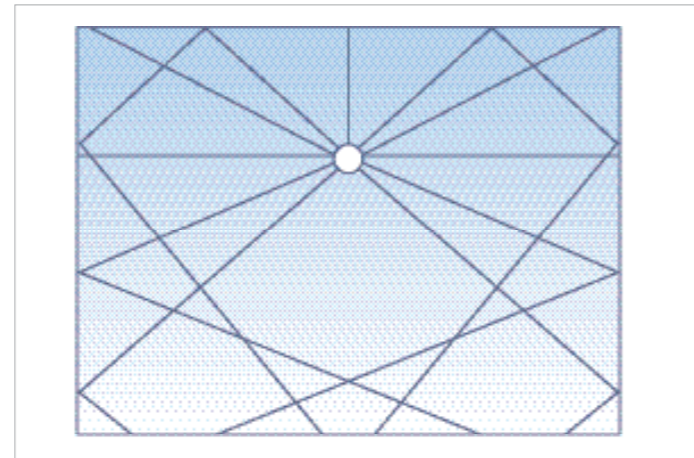
**Note:** Normal glasses and plastics can be used to give protection, because they transmit little or no UVC; some exceptions are special UV glasses, quartz and certain PTFEs

### 3.1.2 Philips TUV lamps for upper-air irradiation using upward facing reflectors

This method of purification can be used to combat bacteria and moulds; it also has the advantage that it can be used occupied interiors without the occupants using protective clothing. The lamps should be mounted in suitable reflectors and aimed to emit no radiation below the horizontal.

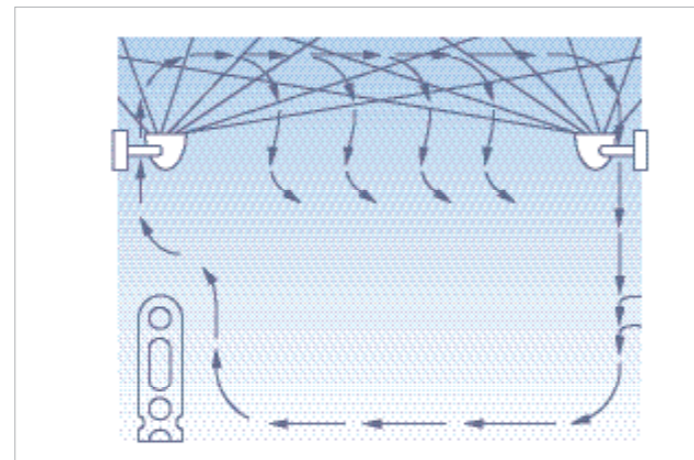
The reflectors should be mounted more than 2.10m above the floor, the lower air thus entirely free of any direct UV light. Air above the 2.10m level maintains a low germ level, because it is subject to direct UVC light.

Free convection of air without forced ventilation causes air movements of about 1.5 - 8 m<sup>3</sup> per minute, thus producing exchanges between the upper treated and lower untreated parts of the room. The process reduces air contamination to fractions of that before the TUV lamps were activated. As an indication for general applications in a simple room, or enclosure, it is advisable to install an effective UVC level of: **0.15 W/m<sup>3</sup>**

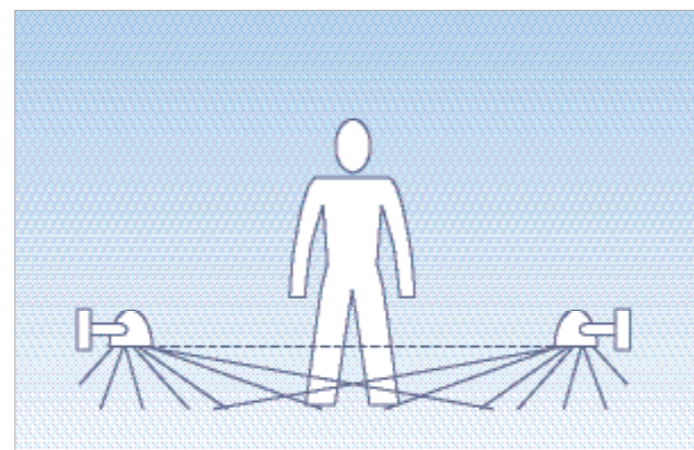


**Figure 15.** Various principles of air purifications

a. Ceiling mounted lamps.



b. Upwards facing reflectors.



c. Downwards facing reflectors.

### 3.1.3 Philips TUV lamps for irradiation of the floor zone using downward facing reflectors

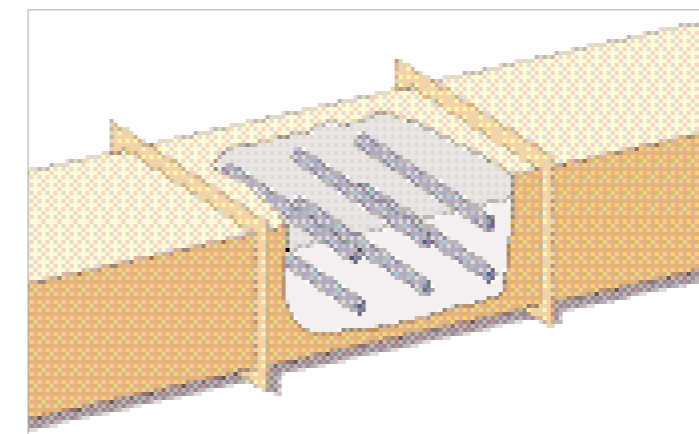
This method is for use in those cases where it is important that the entire room air, even at floor level is rendered as sanitary as possible. In this case, lamps supplementing those irradiating the upper air should be fitted in downward-aimed reflectors at about 60cm above the floor.

In methods 3.1.1, 3.1.2 and 3.1.3 person detectors/systems can be used to deactivate TUV lamps, if necessary.

### 3.1.4 Philips TUV lamps in air ducts

In this method, all the conditioned air is subjected to radiation prior to entry. The injected air can be purified to a specified killing level, depending upon the number of lamps installed and the dwell time, that is the time spent in the effective killing region of the lamp(s); by definition this takes the dimensions of the air duct into consideration. Such systems have a controlled flow rate and their performance can be predicted theoretically. Certain aspects should be borne in mind, however

- These installations are only suitable for bacteria; most moulds have higher resistances to UV, so the air flow rate is not likely to allow a sufficient dwell time to produce a high enough effective dose
- Dust filters should be installed to prevent the lamps from becoming soiled and hence seriously reducing their effective emission
- The number of lamps required in an air purifying chamber in an air duct system is dependent on the required degree of purification, the airflow rate, the ambient temperature, the humidity of the air and the UV-reflecting properties of the chamber walls.

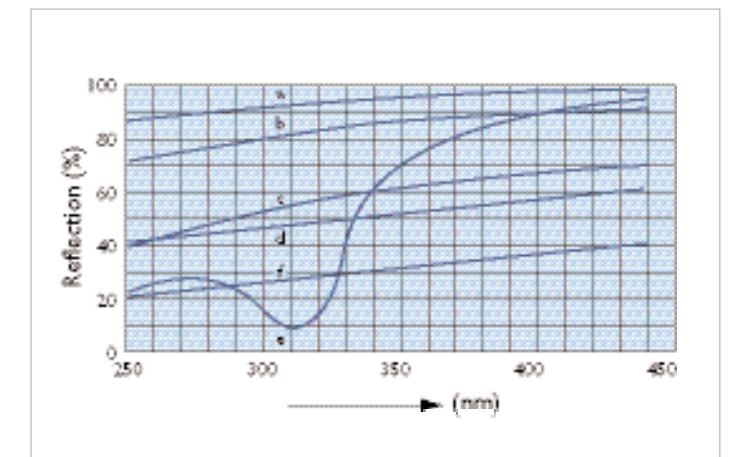


**Figure 16.** Basic arrangement of Philips TUV lamps in an air duct for room purification.

The advantage of purifying air prior to it entering a room is that there is then no limit to the maximum permitted radiation dose, since humans are totally shielded.

Designing duct systems needs to account for practical issues, such as large temperature and humidity variations caused by exterior weather variations, if only because air is often drawn from outside, then released into a room after a single pass over the lamps. Recycling part of the air will allow multiple passes, hence improving system efficiency.

Lining the UV lamps section with aluminum, also increases efficiency. The lamps and the wall of the duct should be easily accessible to permit regular cleaning and easy maintenance, another reason for a modular design. Micro-organisms exposed to UV, experience a normal exponential decrease in population, as already expressed on page 10:



**Figure 17.** Metal surfaces.

- a. Aluminum foil
- b. Chromium
- c. Evaporated aluminum
- d. Nickel
- e. Silver
- f. Stainless steel

$$N_t/N_0 = \exp. (-kE_{eff}t)$$

The rate constant defines the sensitivity of a micro-organism to UV light and is unique to each microbial species. Few airborne rate constants are known with absolute certainty. In water based systems, Escherichia coli are often used as test organism. It is however not an airborne pathogen. For aerosolization tests, often the innocuous Serratia marcescens is used.

### Points to remember when constructing Philips TUV lamp installations in air ducts:

- The surface of the chamber walls should have a high reflectance to UV 254 nm, for example by using anodised aluminum sheet (reflectance 60-90 per cent)
- The lamps should be so arranged that there are no 'shadow' areas
- Lamps should be mounted perpendicular to the direction of the airflow



- Lamps and the inner (reflecting) walls of the chamber should be cleaned frequently using a soft cloth
- Lamps should be changed after the nominal lifetime; an elapsed time meter will help
- An external pilot light should be used to indicate that the lamps are functioning

#### Reflectance of various materials to UV 254 nm

The graphs shown give the spectral reflectance of various metals (figure 17) and organic substances (figure 18) to radiation of different wavelengths. These graphs demonstrate the importance of determining a material's 254 nm reflectance. As can be seen, high reflectance to visible radiation is not consistent with high reflectance to short-wave UV light.

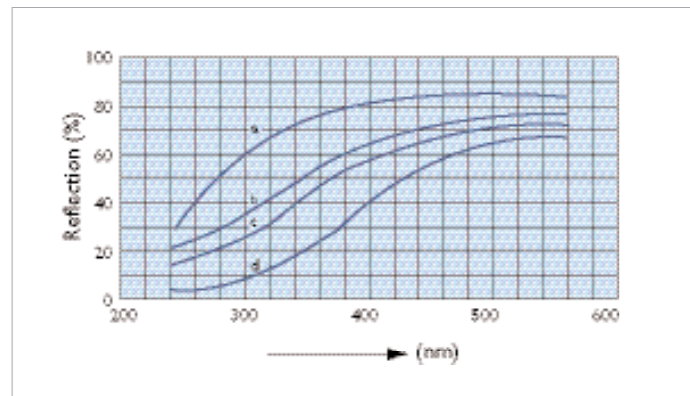


Figure 18. Organic substances

- a. Bleached cotton    c. Linen
- b. White paper        d. White wool

Materials with a high reflectance to 254 nm are used to construct reflectors for both direct and upper-air irradiation. Material with a low reflectance to 254 nm are used where UV light has to be absorbed after performing its function. This latter is necessary to avoid the consequences resulting from the unwanted 254 nm reflections, so ceilings and walls should be treated with a low reflectance material people comfort and safety factors.

#### 3.1.5 Philips TUV lamps in stand-alone units

Recently this method has gained commercial favor by meeting a growing need for a better Indoor Air Quality, (IAQ). Closed stand-alone devices are safe, simple and flexible. In essence the units consist of Philips TUV lamps, mostly PL-L types driven by high frequency ballasts, mounted inside a "light trap" container. The unit incorporates a fan that firstly draws air across a filter, then across the lamp(s). Single and multiple lamp options can be built into a small outer using either single or double-ended lamp options.

For maximum design flexibility, PL-L and PL-S lamps offer the best solutions, because their dimensions are compact, so reducing unit size and because their single ended configuration allows more mounting options.

The units have the benefits of portability and hence more mounting positions viz. wall, floor or ceiling mounted in either permanent or temporary options. A feature of their design is that cleaning and lamp and filter replacement is easy. Additionally their portability can be used to produce immediate results. Variation in UVC dose can be achieved both by varying the number of lamps and their wattage (see also dimming below). As an example, it is possible to use the same physical design dimensions for PL-L lamps with a nominal wattage range between 18 and 95W HO, in single and multi lamp variants. Commercial products are known for as few as 1 x PL-L 18W and as many as 4 x PL-L 95W HO lamps inside the same container, giving a unit capable of producing a 25-fold difference in effective dose. PL-L lamps are more flexible; they have readily available and competitively priced electronic regulating (dimming) ballasts to vary UV output in a simple reliable fashion. Ballasts can be single, double and in the case of 18W, four lamp versions. This adds to the flexibility of portable units.

Material	Reflectance %
Aluminum: untreated surface	40-60
treated surface	60-89
sputtered on glass	75-85
'ALZAK' - treated aluminum	65-75
'DURALUMIN'	16
Stainless steel/Tin plate	25-30
Chromium plating	39
Various white oil paints	3-10
Various white water paints	10-35
Aluminum paint	40-75
Zinc oxide paint	4-5
Black enamel	5
White baked enamel	5-10
White plastering	40-60
New plaster	55-60
Magnesium oxide	75-88
Calcium carbonate	70-80
Linen	17
Bleached wool	4
Bleached cotton	30
Wallpapers: ivory	31
white	21-31
red printed	31
ivory printed	26
brown printed	18
White notepaper	25

Table 3. Reflectance of various materials to UV-254 nm radiation.

## 3.2 Surface purification

Surface purification generally requires high-intensity short-wave UV light. Mostly this means TUV lamps are mounted close to the surface requiring to be kept free from infection or to be purified.

The success of surface purification depends largely on the surface irregularity of the material to be purified, because UV light can only inactivate those micro-organisms that it hits with a sufficient dose. Thus purification can only be successful if the entire surface is exposed to UV light. Micro-organisms sitting in "holes" in a surface are not likely to be overcome by reflections from the hole walls, as can be deduced from the reflectances shown in table 3.

In practice, solid surfaces, granular material and packaging (whether plastic, glass, metal, cardboard, foil, etc.) are purified or maintained germ-free by means of intensive, direct irradiation. Additionally, purified material can be kept largely germ-free throughout its further processing by irradiating the air along its path.

## 3.3 Liquid purification

Germicidal energy radiation is capable of penetrating liquids with varying degrees of efficiency. From a treatment view, liquids can be regarded as similar to air so the further the UV light is able to penetrate the liquid, the more efficient is its action. The degree of efficiency thus greatly depends on the liquid and more particularly its absorption coefficient at 254 nm (table 4). As an example, natural water's transparency to 254 nm may vary by as much as a factor of 10 or more from place to place. Polluted industrial water often needs purification followed by disinfection; here UVC is growing with many thousands of systems in use in North America and Europe, each with a multitude of lamps. Often UV light may supplement or replace conventional chlorination measures (see later). UVC has advantages over chlorinating techniques, because it produces far fewer noxious



Figure 19. UV "cascade" surface purification of spices.

by-products and is unaffected by the pH of the water or its temperature. The reader should note that the latter comment refers to the radiation, not to the lamp, or its environment as described earlier. Micro-organisms are far more difficult to kill in humid air, or in a liquid environment, than in dry air. This is because they limit transmission of 254 nm radiation. In more quantitative terms liquids decrease the germicidal intensity exponentially according to the formula

$$E_x = E_0 \cdot e^{-\alpha(x)}$$

**$E_x$  intensity at depth  $x$**   
 **$E_0$  incident intensity**  
 **$\alpha$  absorption coefficient**

Liquids with a high  $\alpha$  can only be purified when they are exposed as thin films. A rough indication to estimate penetration depth is  $1/\alpha$ , at this depth the irradiation level will have fallen to  $1/e$  or to 37%. To overcome wall effects where liquids are notoriously static, turbulence or rigorous stirring is necessary for better purification, agitation helps orientate micro-organisms hidden behind particles.

Iron salts (as well as other inorganic salts) and suspended matter in liquids will decrease the effectiveness of germicidal radiation.

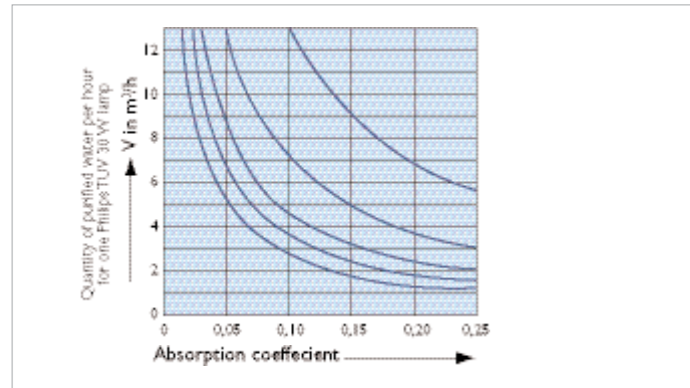
Additionally, it is feasible that organic compounds, in particular, those susceptible to bond fission under UV light, can change the texture and taste of the liquid being treated.

Hence experimentation is needed. In round terms the effective depth of penetration for a 90% kill may thus vary from 3m for distilled water, down to 12cm for normal drinking water and even less in wines and syrups (2.5mm), see table 4.

The penetration depths cause more special techniques to be applied to allow 254 nm radiation to penetrate sufficiently, these include generating "thin films" and or slow speed presentation to the radiation, so that a sufficient dose can be applied.

If an UV lamp has to be immersed in a liquid, it should be enclosed in a quartz or UVC transparent PTFE sleeve. Installations for purifying liquids may have the following forms:

1. One or more lamps enclosed in a quartz container or one of similar material (with a high transmittance at 254 nm), which is surrounded by the liquid to be purified. A multiple of such configurations can be used inside one outer container.



**Figure 20.** Volume of purified water  $V$  as a function of the absorption coefficient  $\alpha$  (for distilled water  $\alpha = 0.007\text{-}0.01/\text{cm}$ , for drinking water  $\alpha = 0.02\text{-}0.1/\text{cm}$ ) with respect to different degrees of purification (in terms of Escherichia coli).

2. A quartz tube (with high transmittance at 254 nm) transporting liquid surrounded by a cluster of lamps in reflectors or by an integral reflector Philips TUV lamp e.g. Philips TUV115WVHO-R.
3. Irradiation by means of lamps installed in reflectors or integral reflector Philips TUV lamps e.g. Philips TUV115WVHO-R mounted above the surface of the liquid.

Example of absorption coefficients	
Liquid	$\alpha$
Wine, red	30
Wine, white	10
Beer	10-20
Syrup, clear	2-5
Syrup, dark	20-50
Milk	300
Distilled water	0.007-0.01
Drinking water	0.02-0.1

**Table 4.** Absorption coefficient ( $\alpha$ ) of various liquids to UV-254 nm per cm depth.



## 4. Applications

### General

The main application areas for UV germicidal lamps may be briefly classified below, although there are many other areas, where the lamps may be employed for various purposes.

- Water purification
- Municipal drinking water
- Municipal waste water
- Residential drinking water
- Water coolers dispensers
- Semiconductors process water
- Spas and swimming pools
- Cooling towers
- Fish ponds and aquariums
- Air purification
- Cooling coils

### 4.1 Water purification (Ref. 7,14)

A wide variety of micro-organisms in the water can cause disease, especially for young and senior people, who may have weaker immune systems. UV light provides purification without the addition of chemicals that can produce harmful by-products and add unpleasant taste to water. Additional benefits include easy installation, low maintenance and minimal space requirements.

UV has the ability to inactivate bacteria, viruses and protozoa. Each type of organism requires a specific dose for inactivation. Viruses require higher doses than bacteria and protozoa. Understanding the organisms to be neutralised will help to determine to size of the UV system that will be required. For example, to kill 99,9% of E.coli, a UV dose of 90 J/m<sup>2</sup> or 9 mW.sec/cm<sup>2</sup> is required.

UV installations are suitable for industrial, municipal and residential markets.

The quality of the water has an important effect on the performance of UV systems. The common factors that have to be considered are iron, hardness, the total concentration of suspended solids and the UV transmittance. Various organic and inorganic compounds can absorb UV.

When there is uncertainty about what may be present in the water, the UV transmittance should be tested. Most drinking water supplies have UV transmittances between 85% and 95%.

Separate treatment technologies often are required to improve the water quality before purification:

- Sediment filters, to remove particles that "shadow" microbes or absorb UV
- Carbon filters, which remove organic compounds and undesirable odors
- Water softeners to reduce hardness

UV is often used in conjunction with Reverse Osmosis (RO) applications. Purification prior to the RO systems increases the durability of the RO membrane by reducing the accumulation of bacterial biofilms.

The reactor of a UV purification device must be designed to ensure that all microbes receive sufficient exposure of the UV.

Most manufacturers of UV equipment use low pressure mercury lamps. High output, (HO) versions are rapidly becoming popular. High capacity drinking water and waste water systems feature medium pressure mercury technology.

The temperature of the lamp surface is one of the most critical factors for UV reactor design. The UV efficiency of the lamp (UV output per consumed electrical wattage) strongly depends on the bulb temperature. (See page 28, figure 28).

The diameter of the protective quartz sleeve should be carefully adapted to the specific power of the lamp (Watts per unit of arc length), as well as temperature and velocity of the water flow.

As the lamp ages, the UV output declines due to solarization of the lamp (glass or quartz) envelope. The quoted dose for a specific unit is the minimum dose that will be delivered at the end of the lamp's life. Most manufacturers offer electronic power supplies, that are more efficient (up to 10%) and operate at lower temperatures. Such ballasts normally withstand wide fluctuations in supply voltage, still providing a consistent current to the lamps.

Factors, that should be considered, when, choosing the right size of UV equipment, in order, to achieve the desired purification objectives are peak flow rate, the required dose and the UV transmittance of the water.

Theoretical calculations should be validated by bioassay tests, for a variety of conditions that include flow rates and variable water quality.

### 4.1.1 Municipal waste water

Chlorine has been used to purify waste water for over a century. However, while chlorine is very effective, it is also associated with environmental problems and health effects. Chlorination by-products in waste water effluents are toxic to aquatic organisms, living in surface waters. Chlorine gas is hazardous to human beings. UV irradiance has proven to be an environmentally responsible, convenient and cost-effective way to purify public waste water discharges. UV purification is much safer than waste water systems that rely on chlorine gas, as it eliminates transport and handling of large quantities of this hazardous chemical. More than thousands of waste water installations all over the world rely on UV purification these days. The required UV dose levels depend on the upstream processes, and range, taking into account flow rates and UV transmittance of the water, between 50 and 100 m J/cm<sup>2</sup>.



Figure 21. Waste water system.

### 4.1.2 Municipal drinking water

Purification of drinking water by UV light is a well-established technology in Europe. Hundreds of European public water suppliers have by now incorporated UV purification. The driving force in Europe was to inactivate bacteria and viruses, but avoid use of chlorine. Recent studies regarding potential negative health effects of purification by-products have led to a critical view on chlorine.

A few fatal waterborne outbreaks of cryptosporidiosis in North America have proven the fact that existing purification and filtration technologies could not guarantee to eliminate cryptosporidium oocysts from the water.

Cryptosporidium parvum is a human pathogen, capable of causing diarrhoeal infections, sometimes even leading to death. The organism can be shed as an environmentally resistant form (oocyst) and persists for months.



Figure 22. UV drinking water plant 405.000 m<sup>3</sup> per day, Tollyaytti (Russia).

Cryptosporidium is almost completely resistant against chlorine. Ozone can be effective, but the water quality and temperature play a significant role. Its small size makes it difficult to remove by standard filter techniques.

Recent studies have verified that UV can achieve significant inactivation of cryptosporidium at very modest doses. Exposures as low as 10 mJ/cm<sup>2</sup> will result in a more than 4- log reduction of concentration.

The effectiveness of UV for cryptosporidium removal, together with stricter limits on purification by-products will pave the way for UV purification in North America. Due to their high UV efficiency, low pressure HO lamps will certainly find their way in many municipal UV drinking water facilities. However, as space always will be a problem, the high intensity medium pressure lamps will be favorite, especially when existing drinking water plants have to be upgraded with a UV extension.

#### 4.1.3 Residential drinking water

Classic Point of Use (POU) / or Point-of- Entry (POE) UV purification systems consist of a low-pressure mercury UV lamp, protected against the water by a quartz sleeve, centered into a stainless steel reactor vessel.

The UV output is monitored by an appropriate UV sensor, providing visual or audible indicators of the UV lamp status. To improve taste and odor of the water POU systems are often used in conjunction with an active carbon filter.

The new ANSI/NSF Standard 55 (UV Microbiological Water Treatment Systems) establishes the minimum requirements a manufacturer will need to become certified for a Class A or B UV system.

Class A POU/POE devices are designed to disinfect micro-organisms, including bacteria and viruses, from contaminated water to a safe level. Waste water is specifically excluded from being used as feed-water. As of March 2002 the UV system has to produce a UV dose of 40 mJ/cm<sup>2</sup>.

Class A devices are required to have a UV sensor, alarming when the proper dose is not reaching the water.

Class B POU systems are designed for supplemental bacterial treatment of treated and purified public drinking water. Such devices are not intended for purification of microbiologically unsafe water. The systems are capable of delivering a UV dose of at least 16 mJ/cm<sup>2</sup> at 70% of the normal UV output or alarm set point. The 2002 version of Standard 55 clarifies all requirements for component certification. For instance, a 15-minute hydrostatic pressure test is needed.

#### 4.1.4 Water coolers, dispensers

Water vending machines store and dispense water that is non-chlorinated. The machines must be licensed by local health service departments. One of the requirements for the license is that the vending machine is equipped with a purification unit to reduce the number of bacteria and other micro-organisms.

Bottled water coolers, which also dispense non-chlorinated water, are not required to contain a purification unit.

However, without an active purification system, also bottled water cooler reservoirs are subject to biofilm growth. Such biofilms act like a breeding place for bacteria, protected by the gel-like substance. Bacteria contamination, regardless of whether it is non-harmful or even beneficial, is not a quality to be associated with drinking water. To avoid biofilm growth often simple UV reactors are being introduced.



Figure 23. POU residential drinking water UV Purification device.

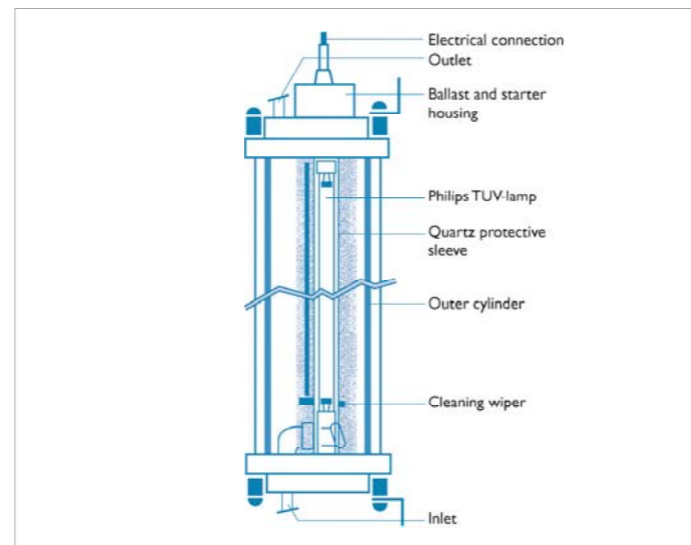
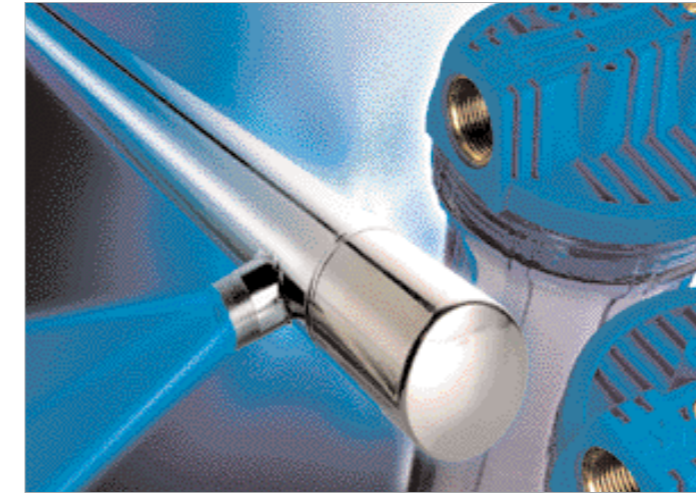


Figure 24. Basic sketch of TUV lamp operated water-purifying unit for general use.

#### 4.1.5 Semiconductors process water

Organic compounds, present in the rinse water, can affect production yields and product quality in the semiconductor industry. The total organic carbon (TOC) contamination level is specified to be less than one part per billion (ppb) for ultrapure water, used for this application. UV light represents a powerful technology that has been successfully introduced in the production of ultrapure water for semiconductor, pharmaceutical, cosmetics and healthcare industries.

Its powerful energies can be applied, not only for purification, but also TOC reduction and destruction of ozone and chlorine.



Two different UV wavelengths are employed, 254 nm and 185 nm. The 254 nm energy is used for purification. It can also destroy residual ozone, present in the water. The 185 nm radiation decomposes the organic molecules. It carries more energy than the 254 nm and is able to generate hydroxyl free radicals from water molecules. These hydroxyl radicals are responsible for oxidizing the organics to carbon dioxide and water molecules. 185 nm radiating lamps are made of special quartz, with high transmittance for the lower wavelengths. Typical dosage requirements range from 100 to 500 mJ/cm<sup>2</sup>. Philips XPT amalgam lamps in a 185 nm version, but also Philips HOK and HTK medium pressure lamps can provide excellent solutions.

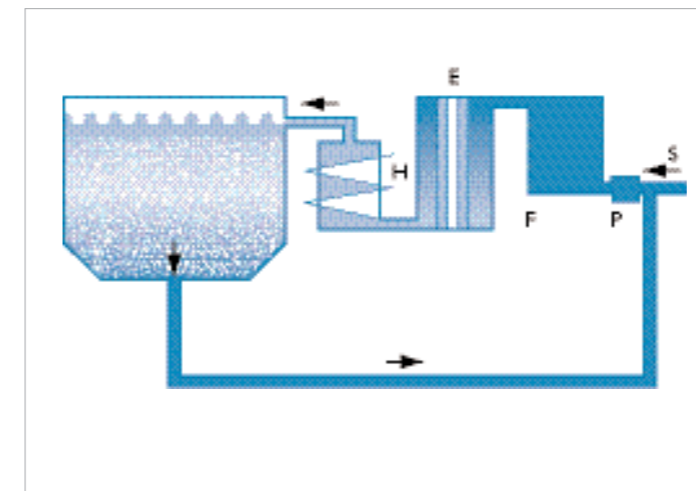


Figure 25. Schematic representation of a water purification system for a private swimming pool E=U.V. radiator F=filter H=heating P=pump S=fresh water supply.

#### 4.1.6 Spas and swimming pools

Philips TUV lamps are used to supplement the traditional methods of water treatment. Importantly, with UVC as a supplement, chlorination methods need less chlorine for the same result. This is welcome both for those with allergies and those with a distaste for chlorine. The reason that UVC is not suitable for sole use is that swimming pool water circulation has to take into consideration solids, inorganic compounds, hence filtration and chemical processes are also needed. A standard technique is to circulate part of the water through a continuous flow UVC device, thus creating a partial closed loop system; this in tandem with the chlorinator produces effective purification. It can lower the chlorine dose up to 50%.

#### 4.1.7 Cooling towers

Cooling towers and re-circulating loops are often dirty, warm and rich in bio-nutrients. They are perfect breeding places for micro-organisms.

Chemical compounds, like chlorine or ozone, are fed into the system in regular intervals, to control the rate of biological growth. UV will substantially decrease the costs of purification, without any safety or environmental issues.

#### 4.1.8 Miscellaneous

##### Fish ponds

Fishponds owners are often troubled by phototrophic micro-organisms. These are typical water organisms widely distributed in both fresh and salt water. Phototrophic bacteria contain photosynthetic pigment and hence they are strongly colored and appear as dense suspensions of either green, olive, purple-violet, red, salmon or brown. Seasonal effects may lead to massive growth ("flowering of the water") as light helps chlorophyll synthesis.

If algae are to be destroyed or their growth inhibited, either a high dose of UV 254 nm radiation is needed or a long irradiation time. These conditions can be met relatively easily by creating a closed loop system whereby the water is presented to the UVC source a number of times per day. The lamp is encased in a quartz tube. In practice, it has been found that, for instance, a Philips TUV PL-S 5W lamp in series with a filter can keep a 4.5K liter (1,000 UK gallons) pond clear. For larger pond or pool volumes higher output lamps are needed on a pro rata scale. The process is thought to be that algae are split, recombine to form larger molecular chains, which can be removed by the filter, or are so large that they sink to the bottom of the pond.



### Aquariums

Aquariums present two problems: one is that they become swamped with algae; the second is that parasites may cause fish diseases. Both can occur in either freshwater or marine aquariums; warm water provides an excellent condition for micro-organisms and the lighting features used also promotes algae growth. The same system as used for ponds is advocated, using no more than a Philips TUV PL-S 5W lamp for a private aquarium. A low pump speed will create a long dwell time across the lamp, so helping both bacteria kill rate and algae agglomeration. Using UVC in ponds and aquariums is also beneficial because it can destroy parasites introduced by new fish; the latter can be catastrophic in many cases. UVC treatment provides an effective solution particularly for suspended zoospores. Multiplication does not take place and aquariums can be free of parasites within a very short time. Even affected fish soon cease to display symptoms of morbidity.

Other applications using ultraviolet (UV) for water purification are: fish farming, ballast water for ships, agriculture, etc.

### 4.2 Air purification

Indoor air is trapped, often re-circulated and always full of contaminants such as bacteria, viruses, moulds, mildew, pollen, smoke and toxic gasses from building materials. Increasing levels of such contaminants act as triggering mechanisms for a variation of diseases of which asthma is the most prominent.

For offices and in industrial environments, so called HEPA (High Efficiency Particulate Air) filters are installed in HVAC ductwork. Very fine fibers, pressed together, form a structure with openings, too small for most particulate contaminants. Such filters are effective, but always will give rise to considerable drop in air pressure. In recent days, growing concern for indoor air quality has led to new measures. Application of UV in air ducts for ventilation, heating and cooling purposes has proven to provide adequate protection against airborne pathogens.



For domestic use some very different basic types can be considered:

- Fiber mesh filters, generally designed for a particle size of 25 microns or larger
- Activated carbon filters, which will neutralise some gasses, smoke and odors
- Electronic air cleaners, which charge particles such as dust, pollen and hair. The charged materials are attracted by a series of opposite polarity charged metal plates
- Ozone and ion generators
- UV light, the only treatment, truly lethal to micro-organisms

With patients and visitors bringing in pathogens that cause diseases such as tuberculosis, wards, clinics, waiting and operation rooms and similar areas should be protected against the risk of infection in personnel and patient populations, if possible at a reasonable cost!



Common traditional disease controlling methods in hospitals are:

- Ventilation: dilution of potentially contaminated air with uncontaminated air
- Negative pressure isolation rooms
- HEPA (High Efficiency Particulate Air) filtration

UV germicidal irradiation provides a potent, cost effective solution to upgrade protection against infection. (Ref. 12,13)

Especially, upper-air purification has proven to be very effective to supplement existing controls for TBC and other airborne diseases (Ref. 8). Many disease-causing organisms circulate on air currents in "droplet nuclei", 1 to 5 micron in size, that are expelled with a cough, sneeze or even with speech. These droplet nuclei can be inhaled, spreading infections. It is estimated that up to 99% of airborne pathogens are destroyed with adequate air circulation and UV exposure.

### 4.3 Cooling coils

Air conditioner cooling coils are almost always wet and dusty and thus can serve as an ideal breeding ground for moulds, a known allergen. Coil irradiation with UV drastically reduces or prohibits growth of moulds. At the same time heat exchange efficiency is improved and pressure drops decrease. As the coils are constantly irradiated, only a modest UV irradiance is required.



### 4.4 Philips germicidal lamps and their application

UV Purification	Philips TUV T5 mini (+HO)	Philips TUV T8	Philips TUV T12 (+R)	Philips TUV T5 (+HO)	Philips TUV PL-S	Philips TUV PL-L	Philips TUV LP 185 nm	Philips Amalgam TUV XPT	Philips HOK/HTK/HTO
<b>Water</b>									
Municipal drinking water				•				•	•
Municipal waste water				•				•	•
Residential drinking water	•				•	•		•	•
Ultra pure water				•			•	•	•
Process water				•				•	•
Swimming pool				•				•	
Agricultural recycling			•	•		•			
Fish ponds	•	•			•	•			
Aquaria	•				•				
<b>Air</b>									
Space/upper air		•		•	•	•			
Forced air/airco		•		•	•	•			•
Cooling coils		•				•			
Dish dryer etc.		•							
<b>Surfaces</b>									
Food processing				•					•
Packaging			•	•					•

Table 5. Germicidal lamps application

## 5. Lamp data

### General

For a complete survey, see separate product data brochures.

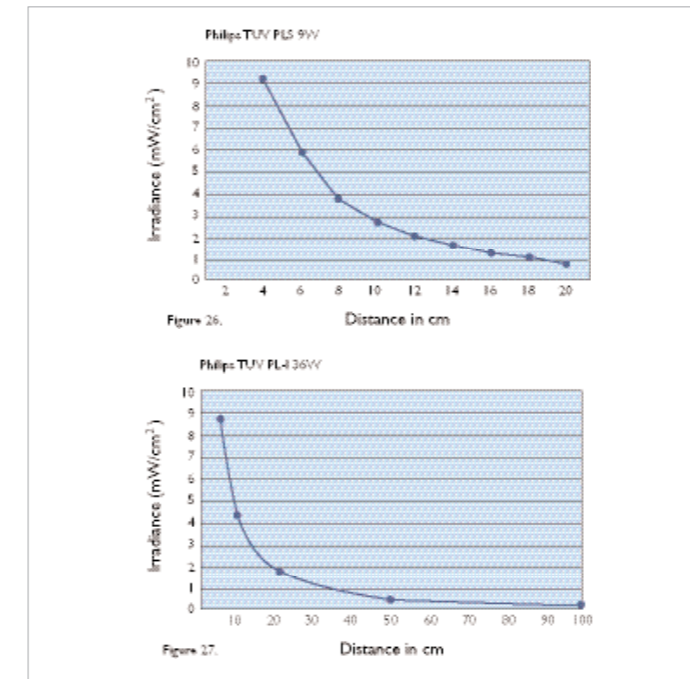
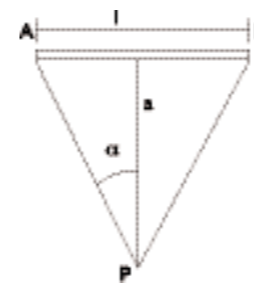


Figure 26 and 27. Demonstrate the variation of UV irradiance with the distance to the lamps.

### 5.1 UV irradiance values

The irradiance E on a small surface in point P on a distance a from an ideal linear radiation source AB of length l amounts to:

$$E = \frac{\varphi}{2 \cdot \pi^2 \cdot l \cdot a} (2\alpha + \sin 2\alpha)$$



$\varphi$  is the total radiation flux (in W). This formula is taken from: H. Keitz, Light calculations and measurements, Philips Technical Library, MacMillan and Co Ltd, 1971.

For a large distance to the lamp we get:

$$E = \frac{\varphi}{\pi^2 \cdot a^2} \dots\dots\dots(a \gg l) \dots\dots\dots(2)$$

At shorter distances the irradiance is proportional to

$$E = \frac{\varphi}{2 \pi \cdot a \cdot l} \dots\dots\dots(a < 0.5 l) \dots\dots\dots(3)$$

For a variety of low pressure mercury TUV lamps, the irradiance values at 1 meter distance are expressed below.

Irradiance values		$\mu\text{W}/\text{cm}^2$
Philips TUV 4W	T5	9
Philips TUV 6W	T5	15
Philips TUV 8W	T5	21
Philips TUV 10W	T8	23
Philips TUV 11W	T5	26
Philips TUV 15W	T8	48
Philips TUV 16W	T5	45
Philips TUV F17T8	T8	88
Philips TUV 25W	T5	69
Philips TUV 25W	T8	
Philips TUV 30W	T8	100
Philips TUV 36W	T8	145
Philips TUV 55W HO	T8	150
Philips TUV 75W HO	T8	220
Philips TUV 115W-R VHO	T12	610
Philips TUV 115W VHO	T12	360
Philips TUV 240W XPT	T6	800
Philips TUV 270W XPT	T10	920
Philips TUV PL-S 5W/2P		9
Philips TUV PL-S 7W/2P		15
Philips TUV PL-S 9W/2P		22
Philips TUV PL-S 11W/2P		33
Philips TUV PL-S 13W/2P		31
Philips TUV PL-L 18W/4P		51
Philips TUV PL-L 24W/4P		65
Philips TUV PL-L 35W/4P HO		105
Philips TUV PL-L 36W/4P		110
Philips TUV PL-L 55W/4P HF		156
Philips TUV PL-L 60W/4P		166
Philips TUV PL-L 95W/4P HO		250
Philips TUV 36T5		144
Philips TUV 64T5		280
Philips TUV 36T5 HO		230
Philips TUV 64T5 HO		442

Table 6. Irradiance values of Philips TUV lamps at a distance of 1.00 meters.

## 5.2 Influence of temperature

The UV efficiency of low-pressure lamps is directly related to the (saturated) mercury pressure. This pressure depends on the lowest temperature spot on the lamp. Optimum UV efficiency is achieved when this temperature is approximately 40°C, see figure 28. Moving air has a strong impact on the tube wall temperature. The cooling effects of air streams (and lower ambient temperatures) can be compensated by over-powering the lamps. Figure 29 shows this effect, comparing standard Philips TUV PL-L 36W lamps with high output 60W versions, having the same dimensions.

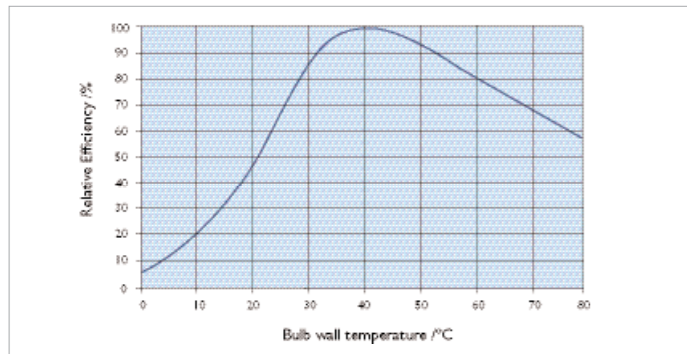


Figure 28. Temperature dependence of mercury lamp.

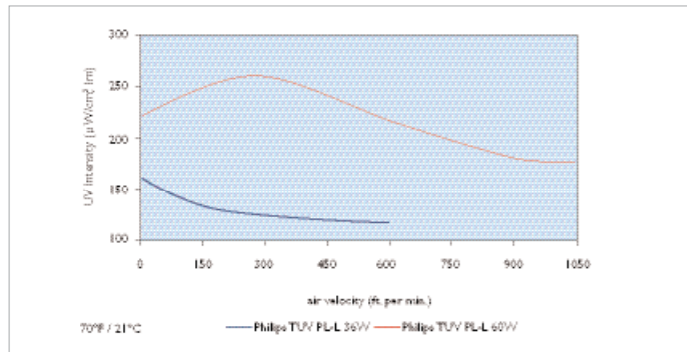


Figure 29. UV vs Windchill Factor.

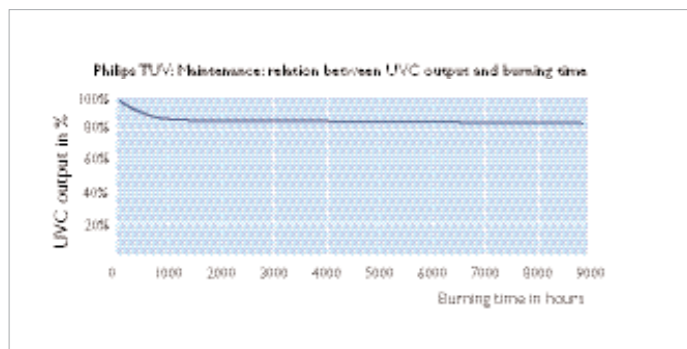


Figure 30. Philips TUV Maintenance.

## 5.3 Lamp life

The life of low pressure mercury lamps (TUV) depends on:

- electrode geometry
- lamp current
- noble-gas filling
- switching frequency
- ambient temperature
- circuitry

The choice of ballast should match the application.

Electronic preheat type of ballasts provide the best conditions for a long lamp life, especially when lamps are switched frequently.

Frequent on/off switching will significantly influence the lamp life.

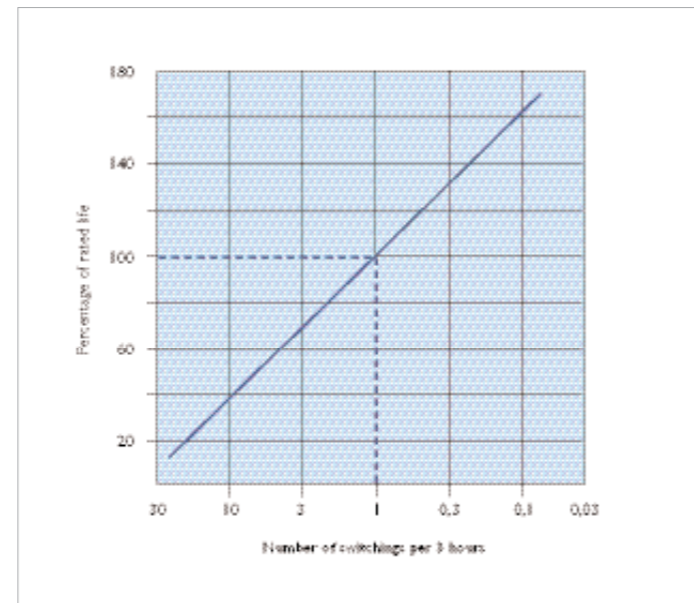


Figure 31. Lamp life.

## 6. References

1. Threshold Limit Values, ACGIH, 1999-2000
2. IES Lighting Handbook, Application Volume, 1987, 14-19
3. Legan, LW. UV Disinfection Chambers, Water and Sewage Works R56-R61
4. Grocock, NH, Disinfection of Drinking Water by UV Light. J. Inst. Water Engineers and Scientists 38(2) 163-172, 1984
5. Antopol, SC. Susceptibility of Legionella pneumophila to UV Radiation. Applied and Environmental Microbiology 38, 347-348. 1979
6. Wilson, B. Coliphage MS-2 as UV Water Disinfection Efficacy Test. Surrogate for Bacterial and Viral Pathogens (AWWA/WQT conference 1992)
7. Wolfe, RL. Ultraviolet Disinfection of Potable Water: Current Technology and Research. Environmental Sci. Technology 24 (6), 768-773, 1990
8. Brickner, PW; Vincent R.L., First, M, Nardell E., Murray M., Kaufman W.; The application of ultraviolet Germicidal radiation to Control Transmission of Airborne Disease, Public Health Reports / March-April 2003, VHI 18
9. Abboud N., Water Conditioning and purification, June 2002. P. 38-39
10. Biological Effects of ultraviolet Radiation. W. Harm, Cambridge University Press, 1980
11. Jagger, J. Introduction to Research in ultraviolet Photobiology, Prentice Hall, 1967
12. Grun, L and Pitz, N. Zbl. Batt. Hyg., vol. B 159, 50-60, 1974
13. Menzies, D.; Popa, J.; Hanley, J.A.; Rand, T.; Milton, D. K.; Lancet 2003; 362, p. 1785-1791.
14. H. Martiny. Desinfektion von Wasser mit UV Strahlen. Techn. Univ. Berlin. 1991

Photographs by courtesy of:

- Lumalier, Memphis USA ([www.lumalier.com](http://www.lumalier.com))
- LIT Technology, Moscow Russia ([www.lit-uv.com](http://www.lit-uv.com))
- Technilamp UV+IR, Southdal S.A. ([uv.ir@pixie.co.za](mailto:uv.ir@pixie.co.za))
- Trojan Technologies, London Ontario, Canada ([www.trojanuv.com](http://www.trojanuv.com))
- Eureka Forbes, Bangalore India ([www.aquaguardworld.com](http://www.aquaguardworld.com))
- GLA, The Netherlands ([www.gla-uvc.nl](http://www.gla-uvc.nl))

Notes: